

výroba kladek

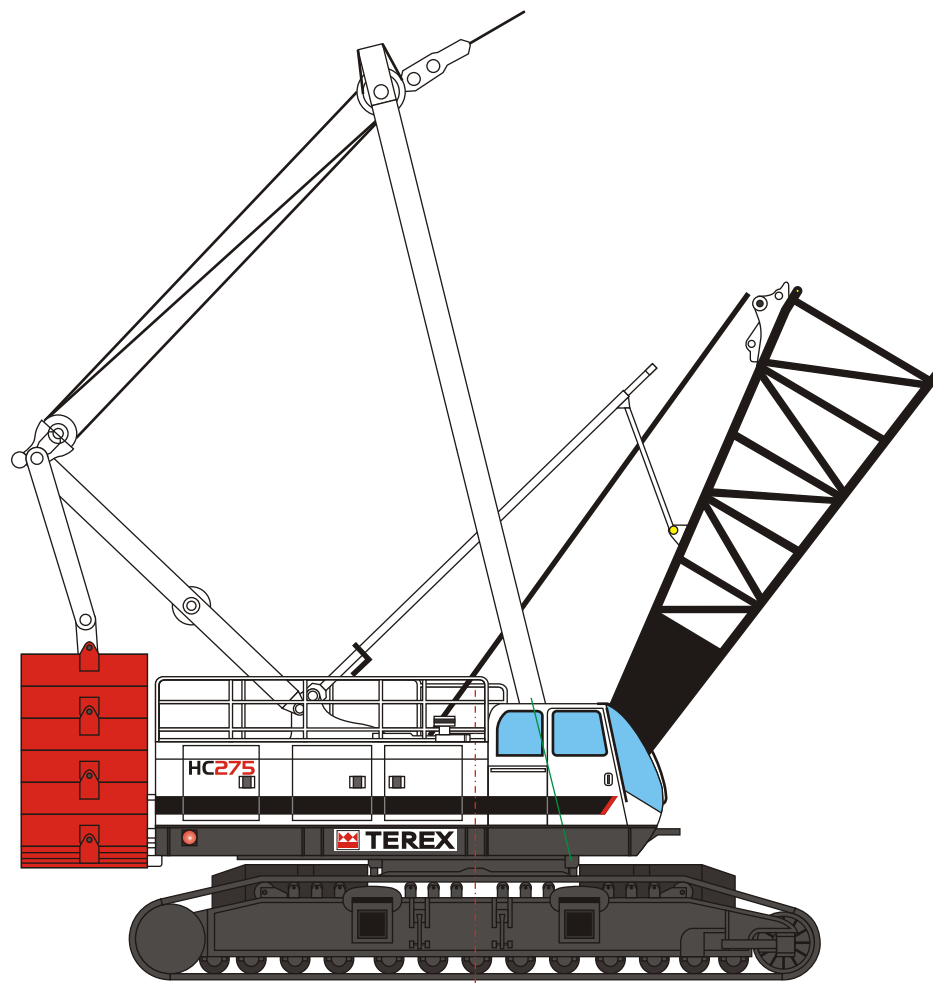

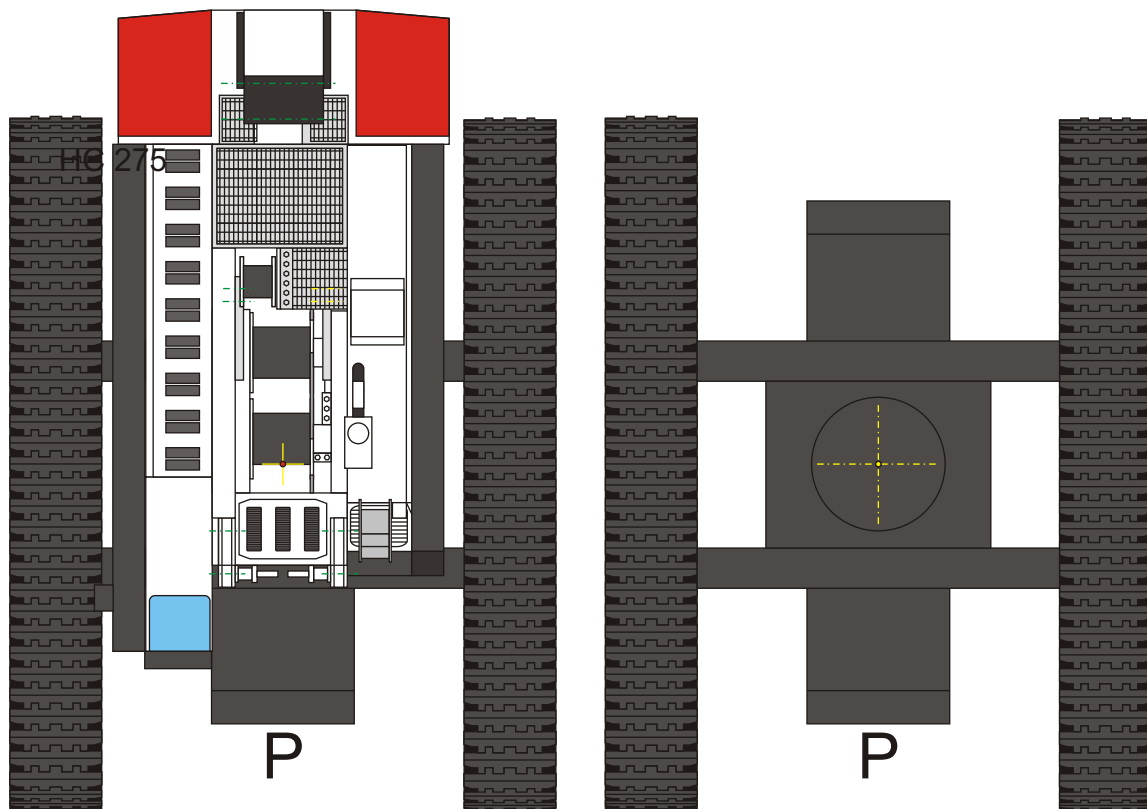

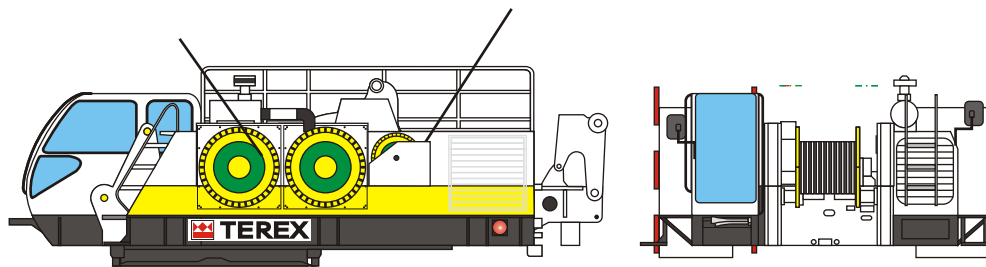

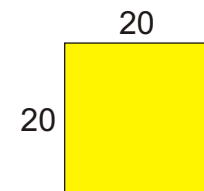
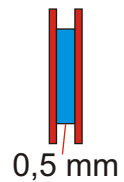
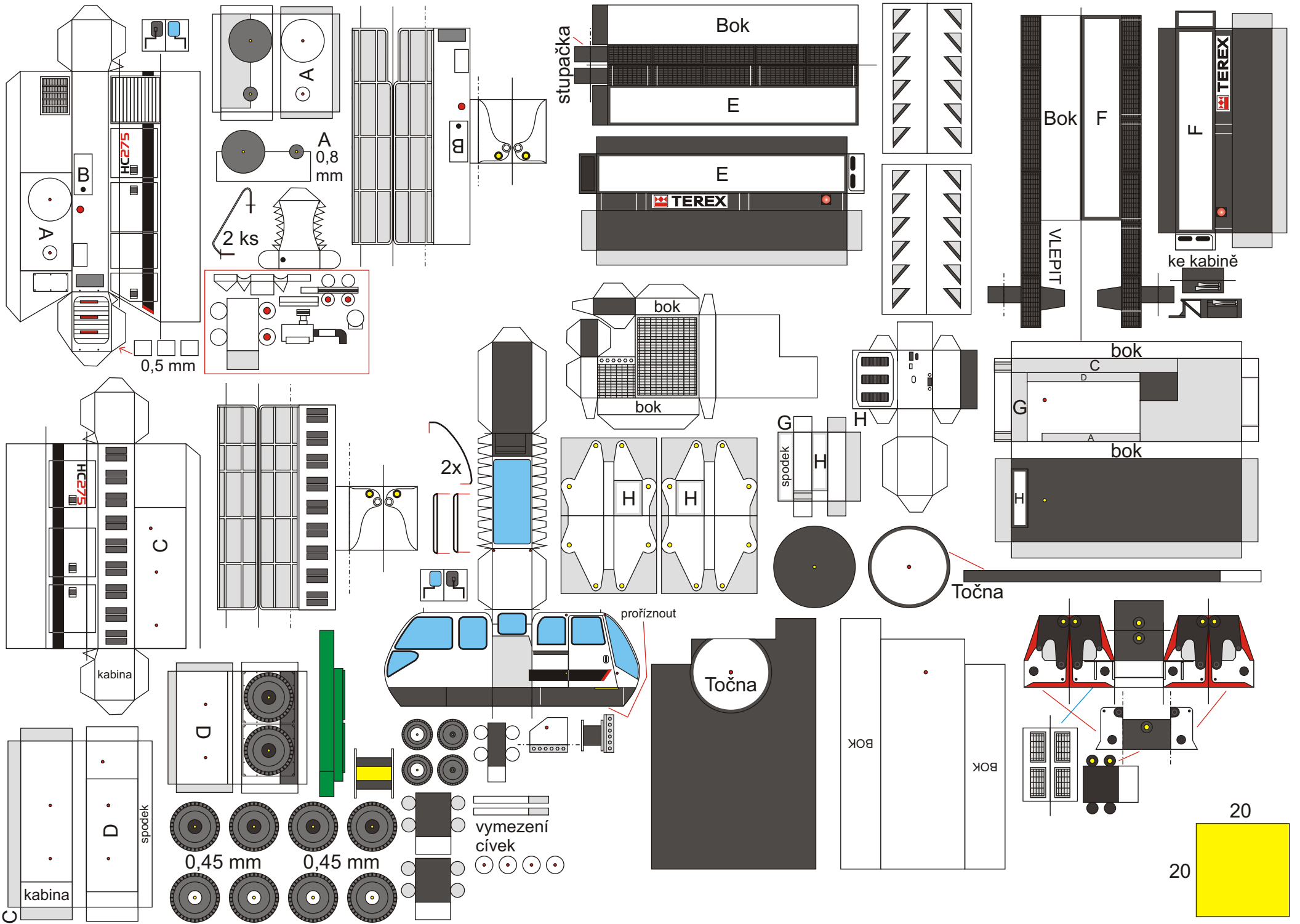
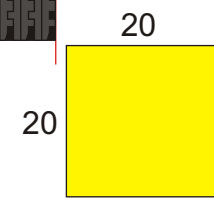
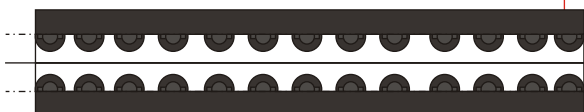
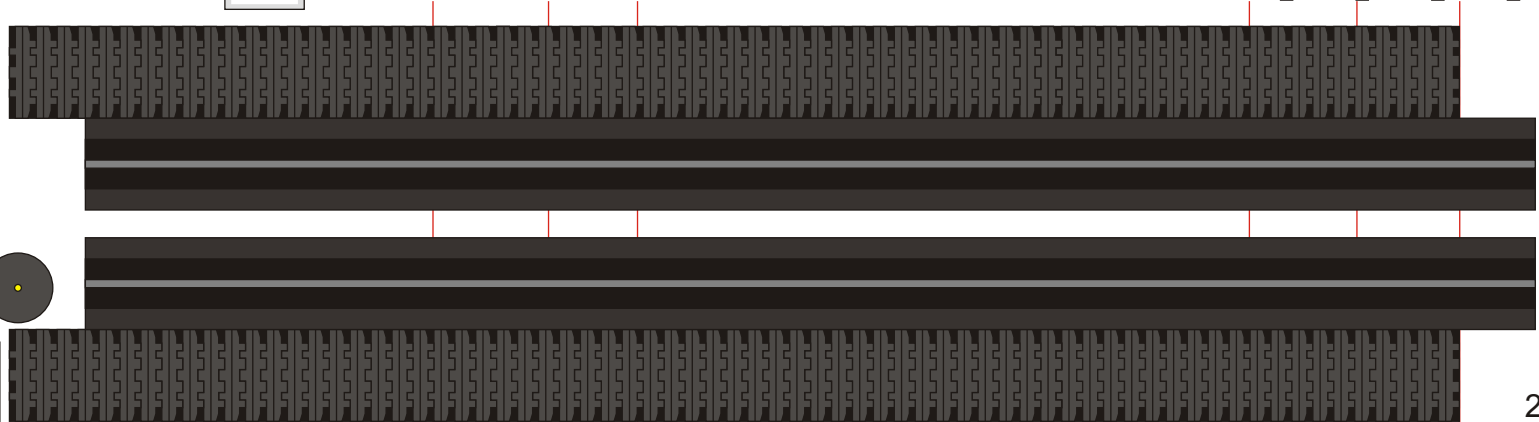
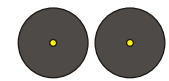
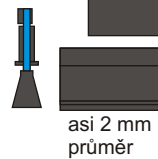
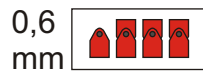
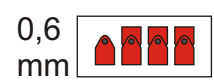
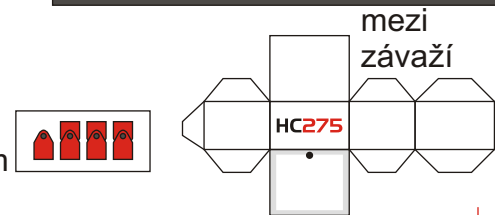
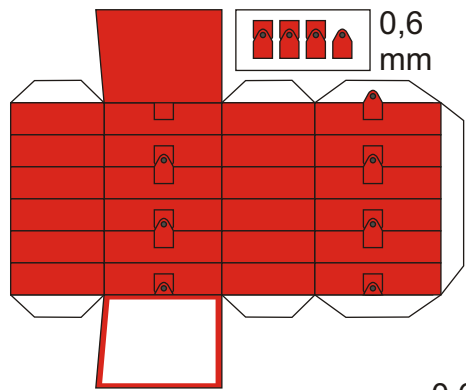
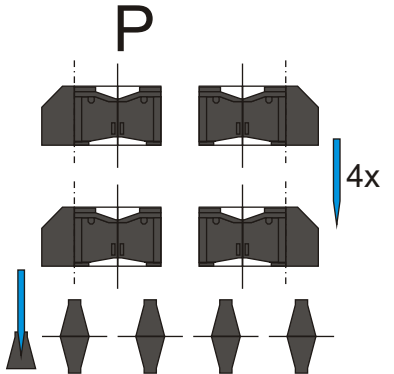
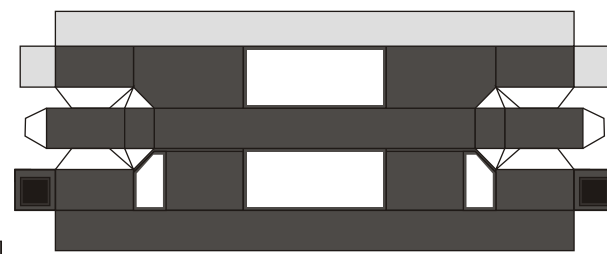
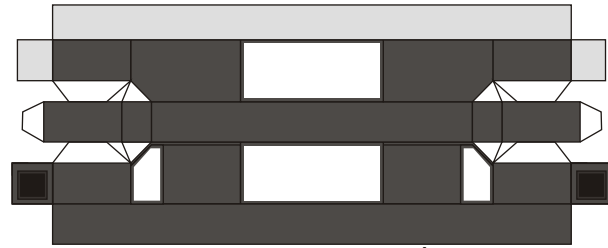
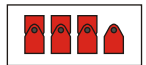
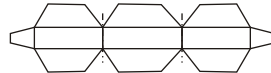
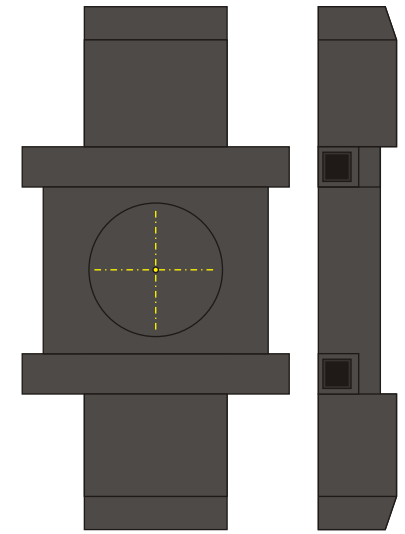
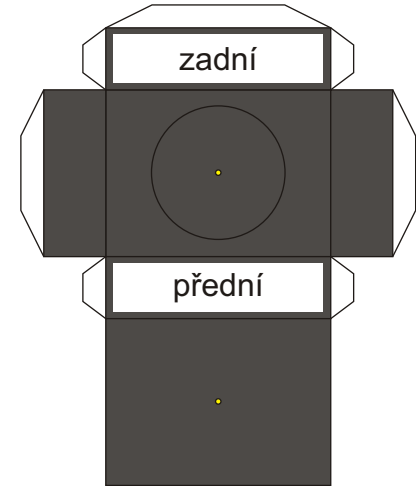
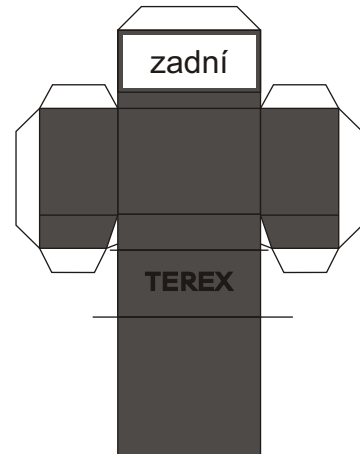
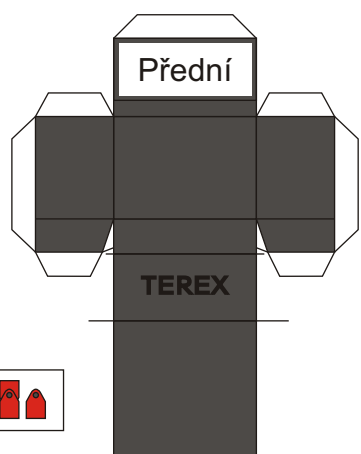
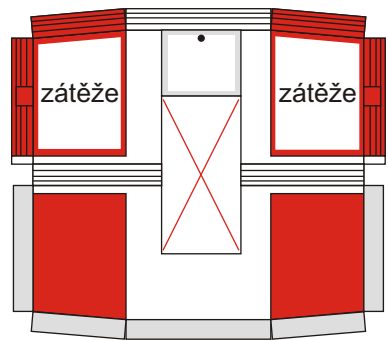
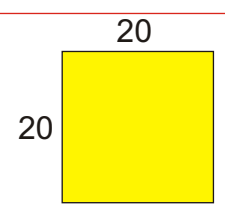
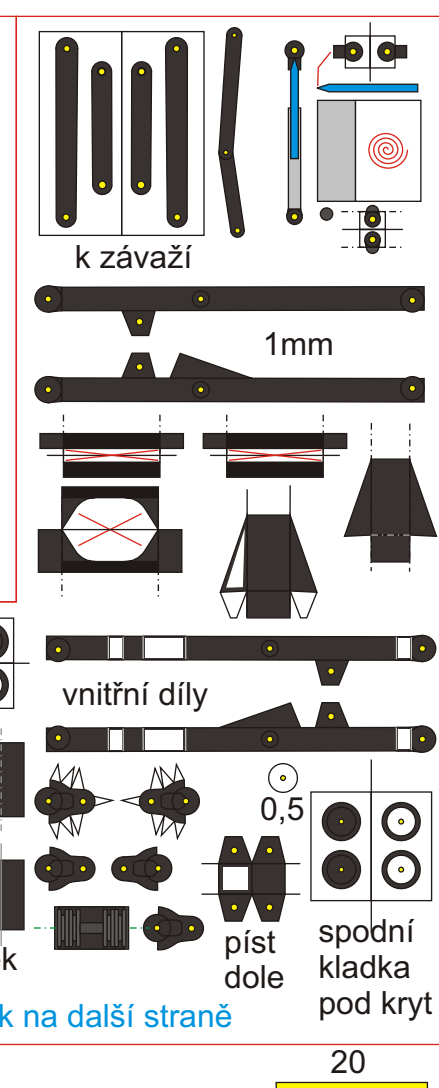
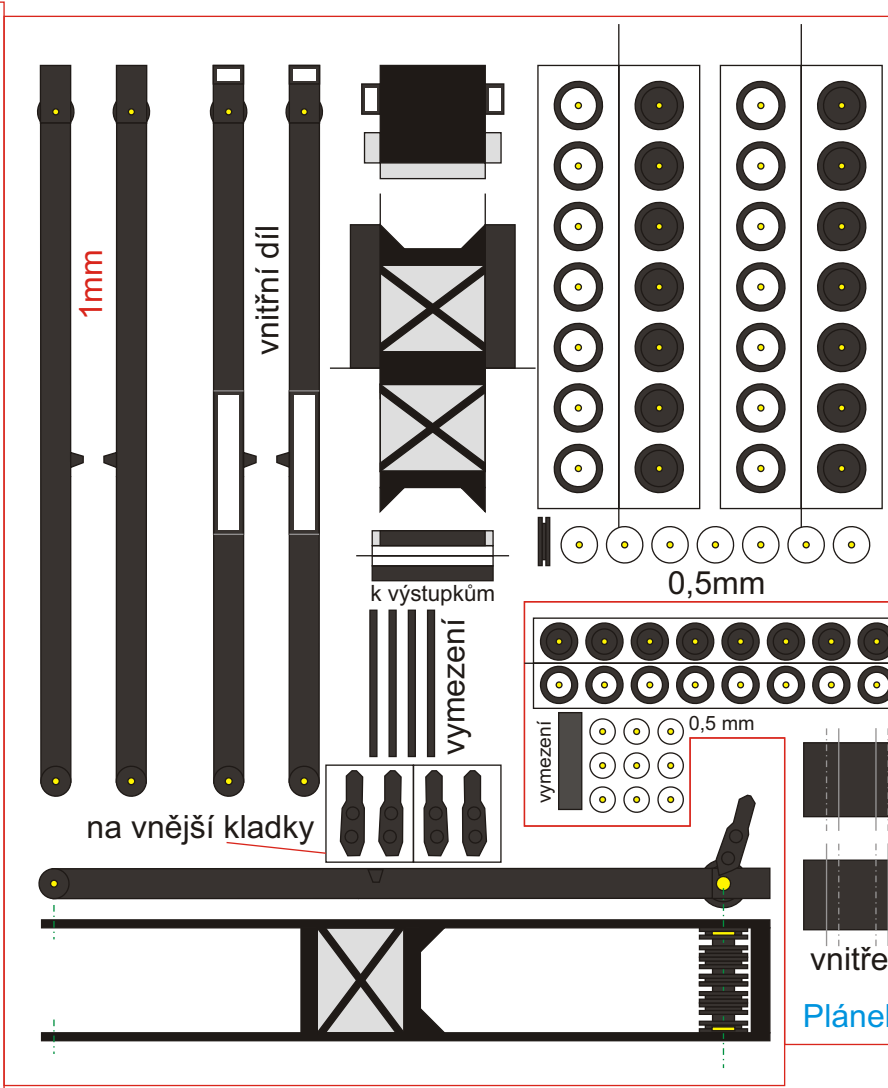
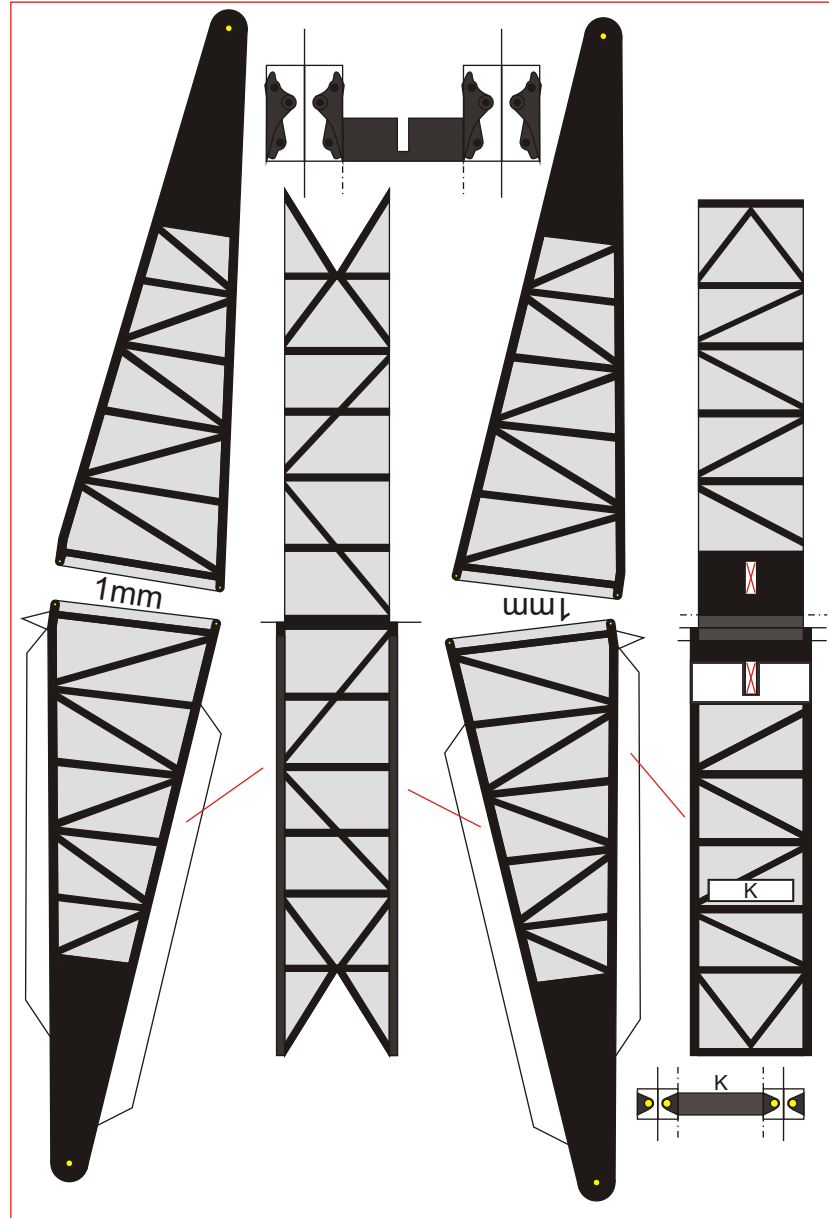
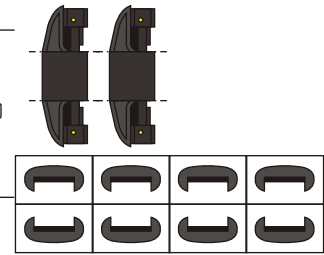
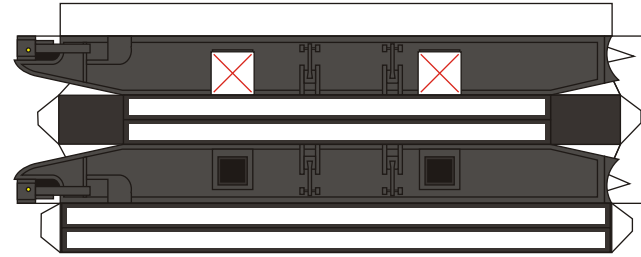
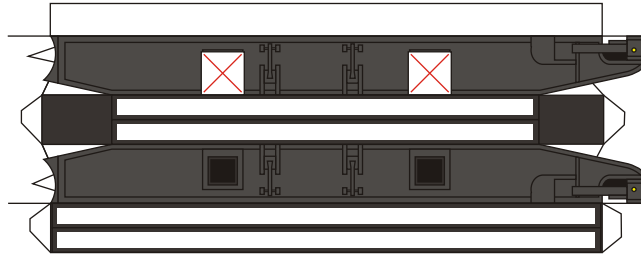
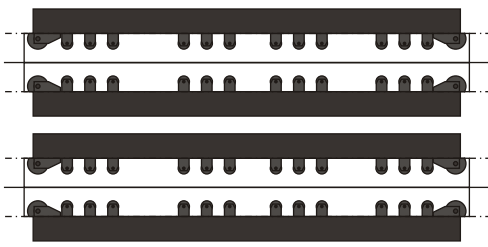

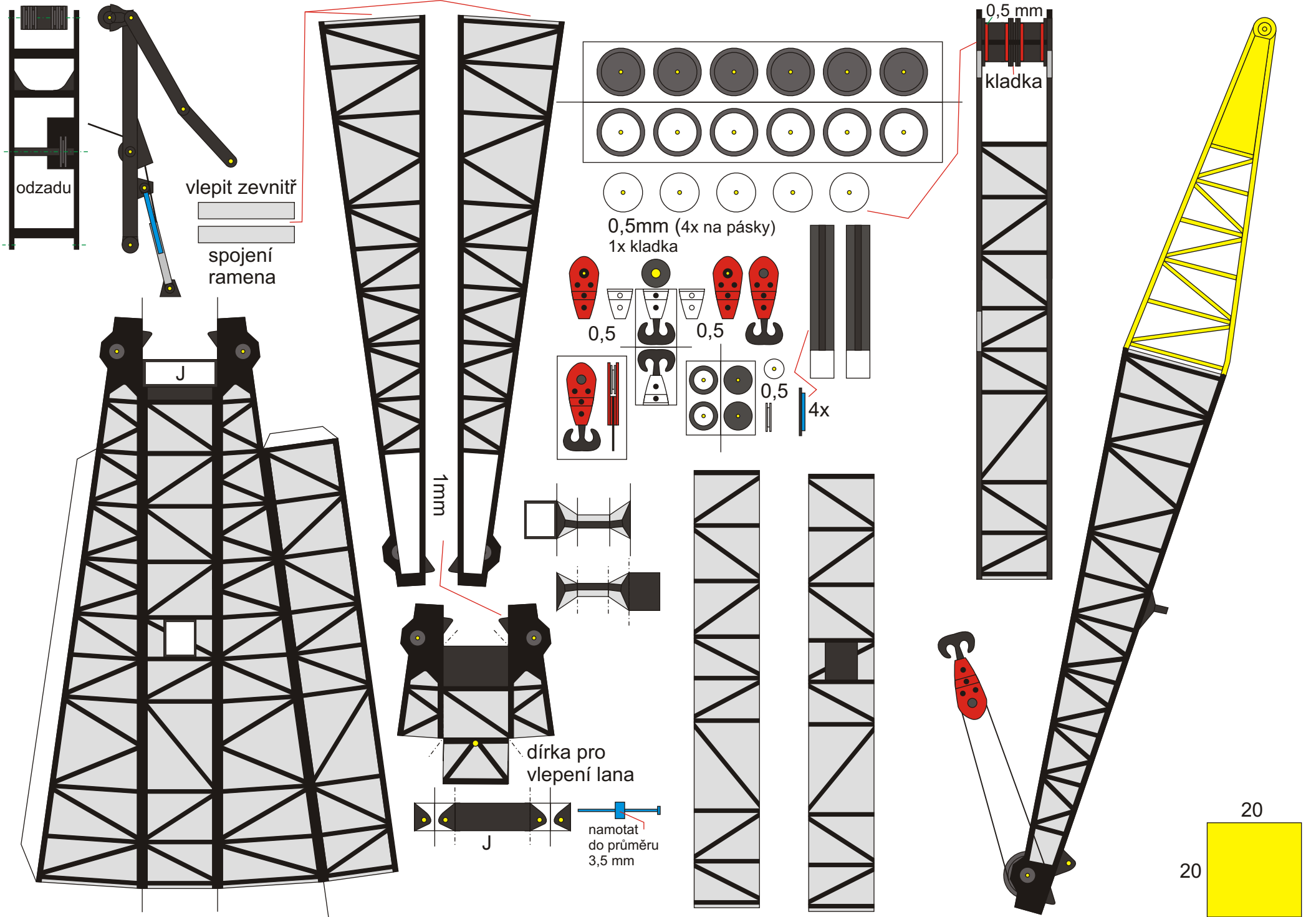

odzadu

vlepit zevnitř

spojení
ramena

J

1mm

0,5

0,5

0,5

4x

0,5mm (4x na pásky)
1x kladka

dírka pro
vlepení lana

namotat
do průměru
3,5 mm

0,5 mm
kladka

20

20

